

MADE IN ITALY



**ANI**

EXTRAORDINARY PASSION

RUBINETTO AUTOMATICO UNIVERSALE CON MOLLA

*AUTOMATIC UNIVERSAL QUICK CONNECTOR WITH SPRING*

*RACCORD AUTOMATIQUE UNIVERSEL AVEC RESSORT*

*AUTOMATISCHER UNIVERSAL-SCHNELLANSCHLUSSHAHN MIT FEDER*

EXTRAORDINARY PASSION **2020**



### CARATTERISTICHE TECNICHE

- **CAMPI DI IMPIEGO:** Circuiti pneumatici, oleodinamici e idraulici.
- **TUBI DI COLLEGAMENTO:** Tubi plastici in Poliuretano (PU) Polietilene (PE) Poliammide (PA-PA11/12) - Poliestere (PET) - PVC INTRECCIATO- PTFE – FEP....;
- **PRESSIONE D'ESERCIZIO:** Pressione massima consigliata 18 bar.
- **TEMPERATURA:** La temperatura è determinata dalle caratteristiche del tubo impiegato.
- **MATERIALI IMPIEGATI:** Corpo/dado bloccaggio: Ottone Nichelato (UNI EN 12164 CW 614N).. Molle: Acciaio armonico C85.
- **O-RING/ GUARNIZIONI:** Guarnizioni in gomma antiolio NBR esenti da silicone
- **TRATTAMENTO SUPERFICIALE:** Nichelatura
- **FILETTATURA:** Gas cilindrica - ISO 228 (BSPP)

### CARACTERISTIQUES TECHNIQUES

- **CHAMPS D'APPLICATION :** Circuits pneumatiques, oléodynamiques et hydrauliques.
- **TUYAUX DE RACCORDEMENT :** Tuyaux en plastique en polyuréthane (PU) Polyéthylène (PE) Polyamide (PA-PA11/12) - Polyester (PET) - PVC TRESSÉ- PTFE – FEP....;
- **PRESSION DE FONCTIONNEMENT :** Pression maximale conseillée 18 bars.
- **TEMPÉRATURE :** La température est déterminée par les caractéristiques du tuyau utilisé.
- **MATÉRIAUX UTILISÉS :** Corps / écrou blocage : Laiton nickelé (UNI EN 12164 CW 614N).. Ressort : Acier harmonique C85.
- **O-RING / JOINTS TORIQUES :** Joints en caoutchouc anti-huile NBR sans silicone
- **TRAITEMENT SUPERFICIEL :** Nickelage
- **FILETAGE :** Gaz cylindrique - ISO 228 (BSPP)

### TECHNICAL FEATURES

- **FIELDS OF APPLICATION:** Pneumatic, oleodynamic and hydraulic circuits.
- **CONNECTING PIPES:** Plastic hoses in polyurethane (PU), polyethylene (PE) polyamide (PA-PA11/12) - polyester (PET) - INTERWOVEN PVC - PTFE – FEP ...
- **OPERATING PRESSURE:** Maximum recommended pressure 18 bar.
- **TEMPERATURE:** The temperature depends on the pipe characteristics.
- **MATERIALS USED:** Body/Clamping nut: Nickel-plated brass (UNI EN 12164 CW 614N) Springs: C85 Spring steel C85.
- **O-RINGS / WASHERS:** Oil-resistant, silicone-free NBR washers.
- **SURFACE TREATMENT:** Nickel plating
- **THREAD:** Cylindrical gas thread - ISO 228 (BSPP).

### TECHNISCHE SPEZIFIKATIONEN





- **ANWENDUNGSBEREICHE:** Pneumatische, oleodynamische und hydraulische Schaltungen.
- **ANSCHLUSSROHRE:** Kunststoffrohre aus Polyurethan (PU), Polyethylen (PE) Polyamide (PA-PA11/12) - Polyester - GEFLOCHTENES PVC- PTFE – FEP....;
- **BETRIEBSDRUCK:** Empfohlener Höchstdruck 18 bar.
- **TEMPERATUR:** Die Temperatur hängt von den Eigenschaften des verwendeten Rohres ab.
- **VERWENDETE STOFFE:** Körper/:Spannmutter: Vernickeltes Messing (UNI EN 12164 CW 614N). Feder: Federstahl C85.
- **O-RINGE / DICHTUNGEN:** Ölfeste, silikonfreie NBR-Dichtungen
- **ÖBERFLÄCHENBEHANDLUNG:** Vernickelung
- **GEWINDE:** Zylindrisches Gasgewinde - ISO 228 (BSPP).



# 60/MF | 60/MG

ATTACCO A BAIONETTA CON MOLLA | BAYONET CONNECTOR WITH SPRING | RACCORD A BAIONNETTE AVEC RESSORT | BAJONETT-ANSCHLUSS MIT FEDER

- Testina a baionetta
- **MG** = Girevole - **MF** = Fisso
- Tête à baïonnette
- **MG** = Pivotant - **MF** = Fixe
- Bayonet chuck
- **MG** = Swivelling - **MF** = Fixed
- Bajonettkopfteil
- **MG** = Drehbar - **MF** = Fest

COD.	MOD.	Di X De	f	L	L1				
AH034015	60/MF	ø 4 x 6	ø 3	77	52	13	14	10	41
AH034003	60/MF	ø 5 x 8	ø 3	95	70	13	14	10	41
AH034001	60/MF	ø 6 x 8	ø 4.5	95	70	13	14	10	40
AH034004	60/MF	ø 6,5 x 10	ø 4.5	95	70	15	15	10	50
AH034009	60/MF	ø 8 x 10	ø 4.5	95	70	13	15	10	54
AH034005	60/MF	ø 8 x 12	ø 4.5	117	92	13	17	10	57
AH034010	60/MF	ø 10 x 12	ø 4.5	117	92	15	17	10	58

## GIREVOLE | SWIVELLING | PIVOTANT | DREHBAR

AH034014	60/MG	ø 4 x 6	ø 2.5	80,5	52	14	14	10	47
AH034006	60/MG	ø 5 x 8	ø 3.5	98	70	14	14	10	47
AH034002	60/MG	ø 6 x 8	ø 4.5	98	70	14	14	10	47
AH034007	60/MG	ø 6,5 x 10	ø 4.5	120	70	14	15	10	57
AH034011	60/MG	ø 8 x 10	ø 4.5	120	70	14	17	10	57



60/MF

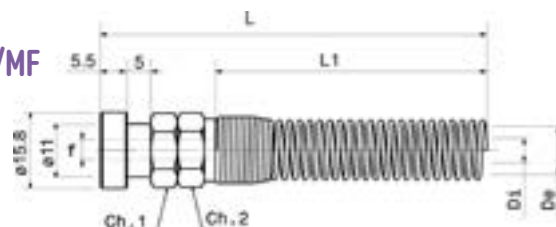



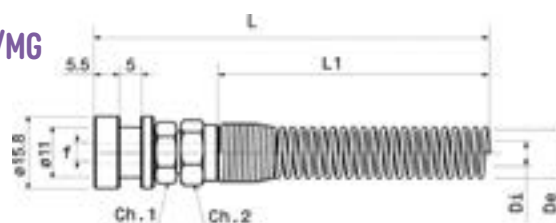

60/MG



# 61/MF | 61/MG

RACCORDO ATTACCO MASCHIO CON MOLLA | MALE THREADED CONNECTOR WITH SPRING  
RACCORD FILIETE MALE AVEC RESSORT | ANSCHLUSSVERBINDUNG MIT AUSSENGEWINDE UND FEDER

- Maschio cilindrico ISO 228 (BSPP)
- **MG** = Girevole - **MF** = Fisso
- Mâle cylindrique ISO 228 (BSPP)
- **MG** = Pivotant - **MF** = Fixe
- Cylindrical male thread ISO 228 (BSPP)
- **MG** = Swivelling - **MF** = Fixed
- Zylindrisches Außengewinde ISO 228 (BSPP)
- **MG** = Drehbar - **MF** = Fest

COD.	MOD.	F	Di x De	f	L	L1	P1				
AH034138	61/MF	1/4M	ø 4x6	ø 2.5	78,5	52	10,5	14	14	10	38
AH034106	61/MF	1/4M	ø 5x8	ø 3	96	70	11	14	14	10	37,5
AH034101	61/MF	1/4M	ø 6x8	ø 4	96	70	11	14	14	10	37
AH034127	61/MF	1/4M	ø 6,5x10	ø 4.5	96	70	11	14	15	10	47
AH034102	61/MF	1/4M	ø 8x10	ø 6	96	70	11	14	15	10	47
AH034110	61/MF	1/4M	ø 8x12	ø 6	96	92	11	14	17	10	48
AH034128	61/MF	3/8M	ø 5x8	ø 3	96	70	10,5	17	14	10	41
AH034119	61/MF	3/8M	ø 6x8	ø 4	96	70	10,5	17	14	10	44
AH034129	61/MF	3/8M	ø 6,5x10	ø 4.5	96	70	10,5	17	15	10	52
AH034120	61/MF	3/8M	ø 8x10	ø 6	96	70	10,5	17	15	10	55
AH034130	61/MF	3/8M	ø 8x12	ø 6	118	92	10,5	17	17	10	61
AH034109	61/MF	3/8M	ø 10x12	ø 8	118	92	10,5	17	17	10	60

## GIREVOLE | SWIVELLING | PIVOTANT | DREHBAR

AH034139	61/MG	1/4M	ø 4x6	ø 2,5	82	52	9,5	14	14	10	48
AH034131	61/MG	1/4M	ø 5x8	ø 3,5	100	70	9,5	14	14	10	48
AH034103	61/MG	1/4M	ø 6x8	ø 4,5	100	70	9,5	14	14	10	48
AH034132	61/MG	1/4M	ø 6,5x10	ø 4,5	100	70	9,5	14	15	10	59
AH034104	61/MG	1/4M	ø 8x10	ø 4,5	100	70	9,5	14	15	10	59
AH034133	61/MG	3/8M	ø 5x8	ø 4,5	122	70	10	17	14	10	54
AH034122	61/MG	3/8M	ø 6x8	ø 4,5	122	70	10	17	14	10	53
AH034134	61/MG	3/8M	ø 6,5x10	ø 4,5	122	70	10	17	15	10	64
AH034123	61/MG	3/8M	ø 8x10	ø 4,5	122	70	10	17	15	10	65



61/MF

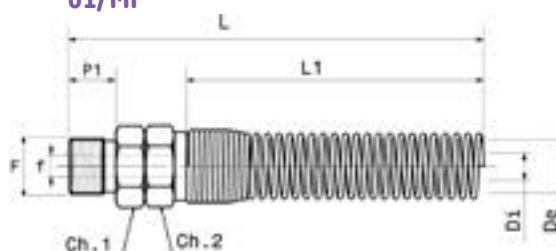

61/MG

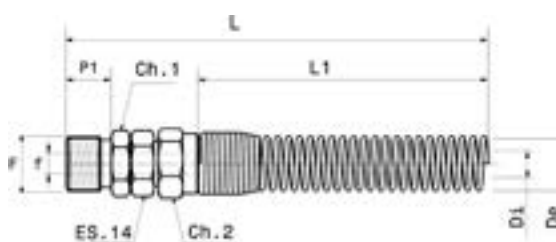





## 62/MF | 62/MG

RACCORDO ATTACCO FEMMINA CON MOLLA | FEMALE THREADED CONNECTOR WITH SPRING  
 RACCORD FILETE FEMELLE AVEC RESSORT | ANSCHLUSSVERBINDUNG MIT INNENGEWINDE UND FEDER

- Femmina cilindrica ISO 228 (BSPP) • Cylindrical female thread ISO 228 (BSPP)
- MG = Girevole - MF = Fisso • MG = Swivelling - MF = Fixed
- Femelle cylindrique ISO 228 (BSPP) • Zylindrisches Innengewinde ISO 228 (BSPP).
- MG = Pivotant - MF = Fixe • MG = Drehbar - MF = Fest

COD.	MOD.	F	Di x De	f	L	L1	P1	🔧1	🔧2	📦	🛒
AH034228	62/MF	1/4F	ø 4x6	ø 2.5	75.5	52	11	15	14	10	38
AH034204	62/MF	1/4F	ø 5x8	ø 3	94	70	11	15	14	10	38
AH034201	62/MF	1/4F	ø 6x8	ø 4	94	70	11	15	14	10	38
AH034205	62/MF	1/4F	ø 6,5x10	ø 4.5	94	70	11	15	15	10	49
AH034202	62/MF	1/4F	ø 8x10	ø 6	94	70	11	15	15	10	50
AH034219	62/MF	3/8F	ø 6x8	ø 4	96	70	12.5	19	14	10	47
AH034207	62/MF	3/8F	ø 6,5x10	ø 4.5	96	70	12.5	19	15	10	53
AH034220	62/MF	3/8F	ø 8x10	ø 6	96	70	12.5	19	15	10	56

### GIREVOLE | SWIVELLING | PIVOTANT | DREHBAR

AH034229	62/MG	1/4F	ø 4x6	ø 2.5	81	52	11	15	14	10	50
AH034208	62/MG	1/4F	ø 5x8	ø 3.5	99	70	11	15	14	10	50
AH034203	62/MG	1/4F	ø 6x8	ø 4.5	99	70	11	15	14	10	49.5
AH034209	62/MG	3/8F	ø 5x8	ø 3.5	99.5	70	11.5	19	14	10	54
AH034222	62/MG	3/8F	ø 6x8	ø 4.5	99.5	70	11.5	19	14	10	57



62/MF

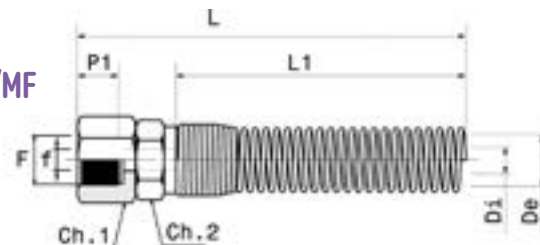

62/MG

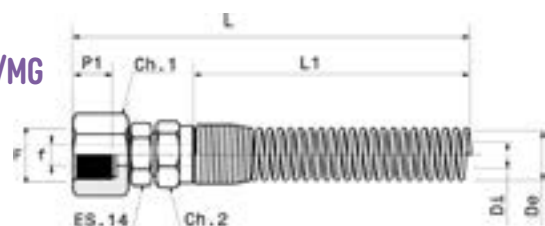

## 63/MF

INNESTO RAPIDO PROFILO ITALIA CON MOLLA | ITALIAN PROFILE QUICK FITTING WITH SPRING  
 EMBOUT RAPIDE PROFIL ITALIE AVEC RESSORT | KUPPLUNGSSTECKER ITALIENISCHES PROFIL MIT FEDER

- Innesto rapido profilo italia 15/A • 15/A italian profile quick fitting with spring
- Ottone nichelato / Acciaio zincato • Nickel plated brass / Zinc-plated steel
- Embout rapide profil Italie 15/A • Schnellkupplung italienisches Profil mit Feder 15/A
- Laiton nickelé / acier zingué • Vernickeltes Messing / Verzinkter Stahl

COD.	MOD.	Di x De	f	L	L1	🔧1	🔧2	📦	🛒
AH034322	63/MF	ø 4 x 6	ø 2.5	91.5	52	13	14	10	48
AH034310	63/MF	ø 5 x 8	ø 3	110	70	13	14	10	48
AH034301	63/MF	ø 6 x 8	ø 4.5	110	70	13	14	10	48
AH034311	63/MF	ø 6,5 x 10	ø 4.5	110	70	15	15	10	57
AH034303	63/MF	ø 8 x 10	ø 4.5	110	70	13	15	10	53
AH034312	63/MF	ø 8 x 12	ø 4.5	130	92	13	17	10	60
AH034304	63/MF	ø 10 x 12	ø 4.5	130	92	15	17	10	56

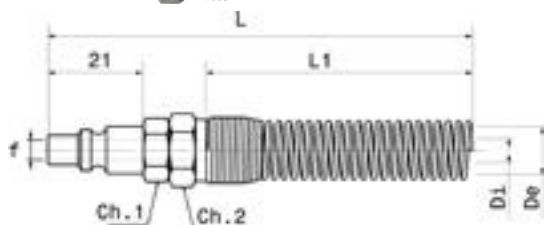

## 63/MF OMNI

INNESTO RAPIDO PROFILO GERMANIA CON MOLLA | GERMAN PROFILE QUICK FITTING WITH SPRING  
 EMBOUT RAPIDE PROFIL ALLEMAGNE AVEC RESSORT | KUPPLUNGSSTECKER DEUTSCHES PROFIL MIT FEDER

- Innesto rapido 15/A OMNI • 15/A OMNI quick fitting
- Acciaio carbonitrurato e zincato • Carbonitrided and zinc-plated steel
- COMPATIBILITÀ CEJN 320 - RECTUS 26 • COMPATIBILITY CEJN 320 - RECTUS 26
- Ottone nichelato / Acciaio zincato • Nickel plated brass / Zinc-plated steel
- Embout rapide 15/A OMNI • Schnellkupplung 15/A OMNI
- Acier carbonitruré et zingué • Karbonitrierter und verzinkter Stahl
- COMPATIBILITÉ CEJN 320 - RECTUS 26 • KOMPATIBILITÄT CEJN 320 - RECTUS 26
- Laiton nickelé / acier zingué • Vernickeltes Messing / Verzinkter Stahl

COD.	MOD.	Di x De	f	L	L1	🔧1	🔧2	📦	🛒
AH034313	63/MF OMNI	ø 5 x 8	ø 3	120	70	13	14	10	57
AH034305	63/MF OMNI	ø 6 x 8	ø 4	120	70	13	14	10	57
AH034314	63/MF OMNI	ø 6,5 x 10	ø 4.5	120	70	15	15	10	68
AH034306	63/MF OMNI	ø 8 x 10	ø 6	120	70	13	15	10	66
AH034315	63/MF OMNI	ø 8 x 12	ø 6	142	92	13	17	10	74
AH034307	63/MF OMNI	ø 10 x 12	ø 8	142	92	15	17	10	76

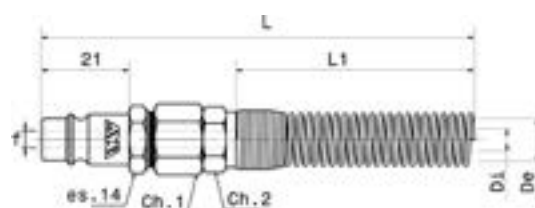

# 64/MF

RUBINETTO RAPIDO UNIVERSALE CON MOLLA | UNIVERSAL QUICK COUPLER WITH SPRING | RACCORD RAPIDE UNIVERSEL AVEC RESSORT | UNIVERSAL-SCHNELLANSCHLUSSHAHN MIT FEDER

- Rubinetto rapido universale a sfere 17/A
- Impiego universale con ogni tipo di innesto
- Raccord rapide universel à billes 17/A
- Utilisation universelle avec chaque type de raccord
- 17/A bearing-type universal quick coupler
- Universal use with all kind of fittings
- Universal-Schnellkupplung 17/A
- Universeller Einsatz mit jeder Art von Kupplung.

COD.	MOD.	Di x De	L	L1				
AH034428	64/MF	ø 4x6	102	52	19	14	10	95
AH034412	64/MF	ø 5x8	120	70	19	14	10	103
AH034401	64/MF	ø 6x8	120	70	19	14	10	104
AH034413	64/MF	ø 6,5x10	120	70	19	15	10	112
AH034403	64/MF	ø 8x10	120	70	19	15	10	112
AH034414	64/MF	ø 8x12	142	92	19	17	10	119
AH034404	64/MF	ø 10x12	142	92	19	17	10	121

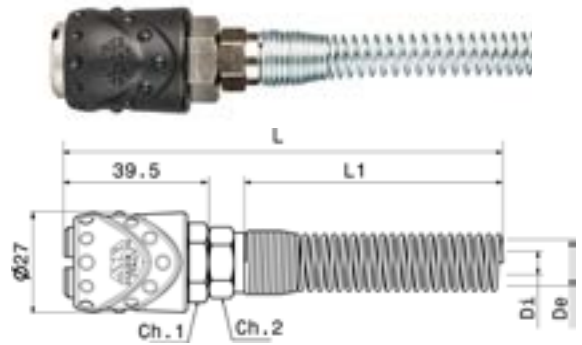

# 64/MF METAL

RUBINETTO RAPIDO UNIVERSALE CON MOLLA | AUTOMATIC UNIVERSAL QUICK COUPLER WITH SPRING  
 RACCORD RAPIDE UNIVERSEL AVEC RESSORT | UNIVERSAL-SCHNELLANSCHLUSSHAHN MIT FEDER

- Rubinetto rapido universale a sfere 17/AM
- Impiego universale con ogni tipo di innesto
- Raccord rapide universel à billes 17/AM
- Utilisation universelle avec chaque type d'embout.
- 17/AM bearing-type universal quick coupler
- Universal use with all kind of fittings
- Universal-Schnellkupplung 17/AM
- Universeller Einsatz mit jeder Art von stecker.

COD.	MOD.	Di x De	L	L1				
AH034424	64/MF METAL	ø 6X8	120	70	22	14	10	88
AH034425	64/MF METAL	ø 8X10	120	70	22	14	10	96

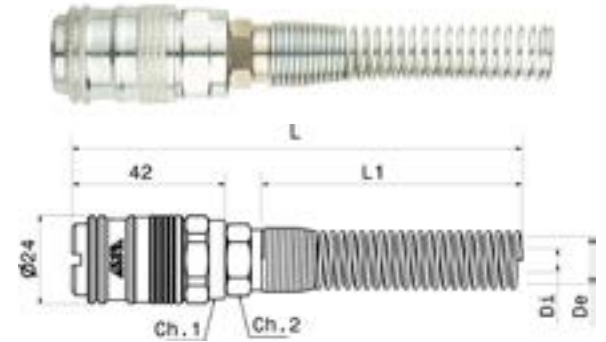

# 64/MF LUX/S

RUBINETTO RAPIDO UNIVERSALE CON MOLLA | UNIVERSAL QUICK COUPLER WITH SPRING | RACCORD RAPIDE UNIVERSEL AVEC RESSORT | UNIVERSAL-SCHNELLANSCHLUSSHAHN MIT FEDER

- Rubinetto rapido universale a sfere 17 LUX/S
- Impiego universale con ogni tipo di innesto
- Raccord rapide universel à billes 17 LUX/S
- Utilisation universelle avec chaque type d'embout.
- 17 LUX/S bearing-type universal quick coupler
- Universal use with all kind of fittings
- Universal-Schnellkupplung 17 LUX/S
- Universeller Einsatz mit jeder Art von stecker.

COD.	MOD.	Di x De	L	L1				
AH034807	64/MF LUX/S	ø 5x8	126	70	19	14	5	120
AH034808	64/MF LUX/S	ø 6x8	126	70	19	14	5	121
AH034809	64/MF LUX/S	ø 6,5x10	126	70	19	15	5	129
AH034810	64/MF LUX/S	ø 8x10	126	70	19	15	5	129
AH034811	64/MF LUX/S	ø 8x12	148	92	19	17	5	136
AH034812	64/MF LUX/S	ø 10x12	148	92	19	17	5	138

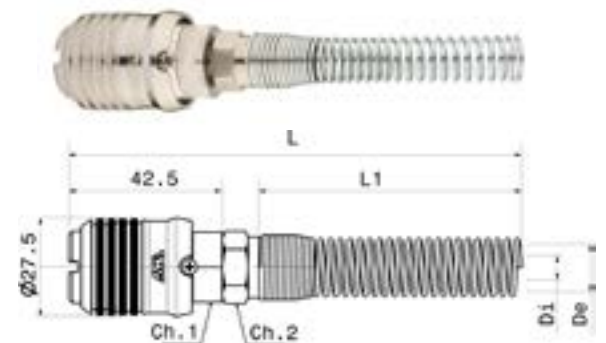

# UR/4 MF

RUBINETTO RAPIDO UNIVERSALE A RULLI CON MOLLA | UNIVERSAL DUAL PIN QUICK COUPLER WITH SPRING  
 RACCORD RAPIDE UNIVERSEL A AIGUILLES AVEC RESSORT | UNIVERSAL-SCHNELLANSCHLUSSHAHN MIT WALZEN UND FEDER

- Rubinetto rapido universale a rulli UR/7
- Impiego universale con ogni tipo di innesto
- Raccord rapide universel à aiguilles UR/7
- Utilisation universelle avec chaque type d'embout
- UR/7 universal dual pin quick coupler
- Universal use with all kind of fittings
- Universal-Schnellanschlussahn mit Walzen UR/7
- Universeller Einsatz mit jeder Art von stecker.

COD.	MOD.	Di x De	L	L1				
AH022521	UR/4 MF	ø 5x8	120	70	19	14	5	120
AH022522	UR/4 MF	ø 6x8	120	70	19	14	5	121
AH022523	UR/4 MF	ø 6,5x10	120	70	19	15	5	129
AH022524	UR/4 MF	ø 8x10	120	70	19	15	5	129
AH022525	UR/4 MF	ø 8x12	142	92	19	17	5	136
AH022526	UR/4 MF	ø 10x12	142	92	19	17	5	138

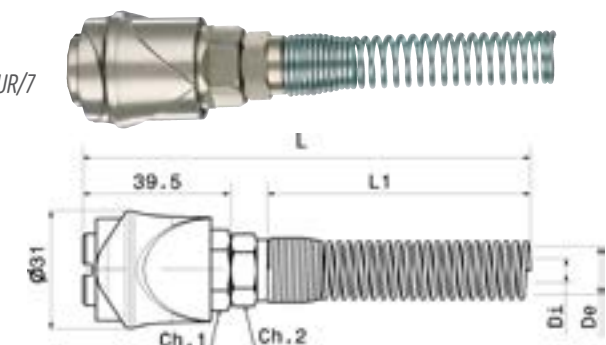



**ANI SPA**  
Via Arzignano, 190  
36072 CHIAMPO (VI)  
ITALY  
tel. +39 0444 420888  
ani@ani.it

[www.ani.it](http://www.ani.it)